



ROOF ACCESS



SMOKE VENTS



LADDERS



ROOF SAFETY

ROOF ACCESS SOLUTIONS
SAFE ACCESS ALL AREAS

An Introduction



The Bilco Company was established in America in 1926 and has for many decades designed and supplied access products for construction and engineering industries all over the world.

The company has been a pioneer in the development of a unique line of horizontal access products, and in 1989 Bilco UK and Europe was formed and has since built a reputation amongst architects, engineers, specifiers and the construction trades for providing the right access solutions.

Since June 2016, Bilco UK has been a part of the home security specialist ERA and now operates alongside floor access products manufacturer Howe Green and riser door and wall access products manufacturer Profab Access. The three companies form the Access 360 division of Tyman UK & Ireland and offer the building services sector a full and comprehensive range of access products.

Bilco UK remains committed to delivering excellent service and products to its markets.

BILCO TODAY

Based in Suffolk, Bilco UK can supply the trade with a range of standard roof hatches, smoke vents, ladders and floor doors in various sizes and materials direct from stock, delivered by a nationwide palletline system or dedicated consignment. Standard items are delivered anywhere in the UK in 3-4 working days and best of all, there's no extra charge. Special products can be manufactured to order.

Bilco UK also provides technical assistance for more complex product requirements. The technical department will assist you to develop a creative design solution for your unique applications. Quality access products comply with current Building Regulations and Legislation, and are engineered to provide many years of trouble-free service.

OUR COMMITMENT

Bilco UK products are designed and fabricated to consistently high quality standards to ensure complete customer satisfaction. As part of its commitment, Bilco UK has implemented a company-wide quality system, which has achieved ISO 9001 and 14001 accreditation. The Bilco Company is committed to producing access products that are unequalled in quality, design and workmanship.

OUR GUARANTEE

Warranty is for a minimum period of ten years from the date of purchase. Electric motors, ladders, special finishes and other special equipment, if applicable, are covered separately.

Don't forget...

For BIM, CAD and NBS specifications see www.bilcok.co.uk



BIM

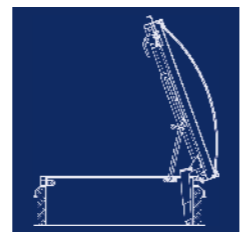

CAD



NBS

Which access hatch is right for you?

First decide on **how frequently** you will be using the hatch, for **what purpose** and **by whom**.

The following chart gives details of the standard sizes available for each type of use, key features and options as well as recommended type of access. All Bilco UK hatches can be supplied in special sizes to order, please contact office for details.

ACCESS TYPE	SPECIFICATIONS			OPERATION		TYPICAL USES					RECOMMENDED ACCESS TYPE		
	Clear Internal Dimensions (mm)	Overall Dimensions (mm)	Weight (kg)	Compression Spring Operation	Powered Operation	Occasional Maintenance	Routine Maintenance	Emergency Escape	Access with Tools and Equipment	Plant and equipment Access	Fixed Vertical Ladder	Companionway Ladder	Fixed Staircase
Ladder Access													
S-50TB	915 x 760	1195 x 1040	60	✓		✓	✓	✓			✓		
E-50TB	915 x 915	1195 x 1195	63	✓		✓	✓	✓			✓		
GS-50TB	915 x 760	1195 x 1040	64	✓		✓	✓	✓			✓		
Companionway Access													
CS-50TB	760 x 1500	1040 x 1780	81	✓	o	✓	✓	✓	✓			✓	✓
Sky Access	1000 x 1500	1300 x 1800	170		✓	✓	✓	✓	✓		✓	✓	✓
Fixed Staircase (Service Stair)													
L-50TB	760 x 2440	1040 x 2720	138	✓	o	✓	✓	✓	✓			✓	✓
SSY-50TB	760 x 3360	1040 x 3640	176	✓	o	✓	✓	✓	✓			✓	
Equipment Access													
F-50TB	1220 x 1220	1500 x 1500	126	✓	o					✓			
Special Sizes													
Single Leaf SS-50TB	Contact Bilco office for details			✓	o	✓	✓	✓	✓	✓	✓	✓	✓
Double Leaf D-50T	Contact Bilco office for details			✓	o	✓	✓	✓	✓	✓		✓	✓
Smoke Vents (CE Marked)													
ESW-50REM	1260 x 1260	1488 x 1488	140		✓	✓	✓	✓			✓		
SKY-1M	1000 x 1500	1300 x 1800	170		✓	✓	✓	✓			✓	✓	
UDF-50REM	1500 x 1620	1728 x 1848	215		✓								Not suitable for access

o = Optional

Contents

Which access hatch is right for you?	3
--------------------------------------	---

ROOF ACCESS HATCHES

Typical Construction	6
Ladder Access	8
Companionway Access	10
Fixed Staircase (Service Stair)	12
Equipment Access	14

SMOKE VENTS

Typical Construction	16
NSHEV	18
Control Panel	20

LADDERS

Fixed Vertical Ladders	23
Ladder Security Gates and Retractable Section	23
Companionway Ladder	26
Ladder Safety Options	27
Retractable Ladders	28

ROOF SAFETY

Step-over Units	31
BWALK-A Roof Mounted Walkways	32

CPDs from Bilco UK	33
--------------------	----

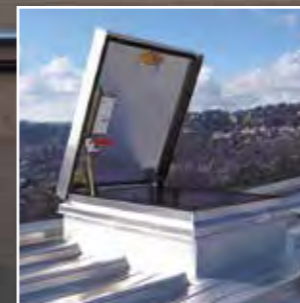

Typical construction of a Roof Access Hatch

- Safe and secure one-handed operation.
- Fully insulated.
- Gasketed weathertight construction.

PERFORMANCE

BS EN 12207:2000	Air Permeability 4.83m ³ /hour/m ² at 600Pa
BS EN 12208:2000	Water Tightness Class 9A
BS EN 12210:2000	Wind Resistance Class E2400
BS EN 1991-1	Snow Load 1200Pa for 1 hour
BS 8200	Impact Resistance Pass
BS EN ISO 140	Acoustic 25dB
BS EN 1627 – 1630	Security Pass
Wind Speed	With Open Cover 30m/s

**TESTED AT
THE NATIONAL
PHYSICAL
LABORATORY**



Heavy duty latch to topside and underside



Can be padlocked from the inside or the outside

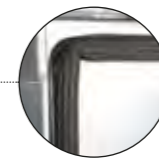

EPDM sponge gasket

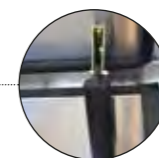

Compression spring operation

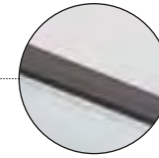

Thermally broken seals

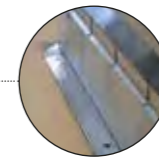

Bilclip flashing system

Hold open arm allows one-handed release and automatically locks cover in open position



Serial number marked for lifetime traceability



Fixing holes and insulated curb. U value of 0.278Wm²/K

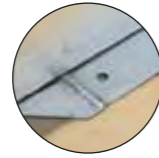

Options

Curb Liners



Shows curb liner flange and apron option

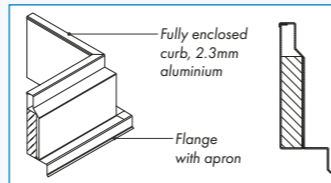
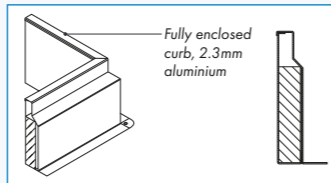
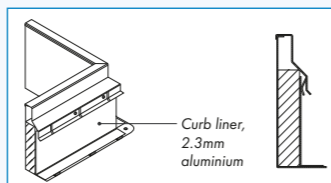

Powered Access Options

for Single or Double Leaf see pages 30 and 31.



Paint Finishes



Keyed Lock Options

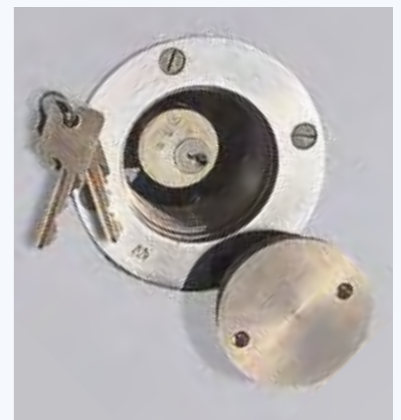

Ladder Access

Solid Insulated Aluminium Cover



Clear Polycarbonate Dome



NOTE

Always maintain three points of contact on the ladder.
Ladder to be positioned opposite the hinge.
Consider LADDER UP® Safety Post for safety when exiting (see page 27).
See page 22 for details of fixed vertical ladders available.



LADDER ACCESS SPECIFICATIONS

PERFORMANCE CHARACTERISTICS:	Thermally broken. 75mm thick polyisocyanurate.
CURB:	305mm high. 140mm flange with 11mm holes provided for securing to the roof deck.
LIFTING MECHANISM:	Compression springs as standard.
HARDWARE:	Heavy stainless steel pintle hinges. Spring latch with interior and exterior turn handles. Interior and exterior padlock hasps. Automatically locks in the open position with a rigid hold open arm.
FINISH:	Mill finish aluminium.
OPTIONS:	Polyester Powder Coating. Curb Liners. Locking options.

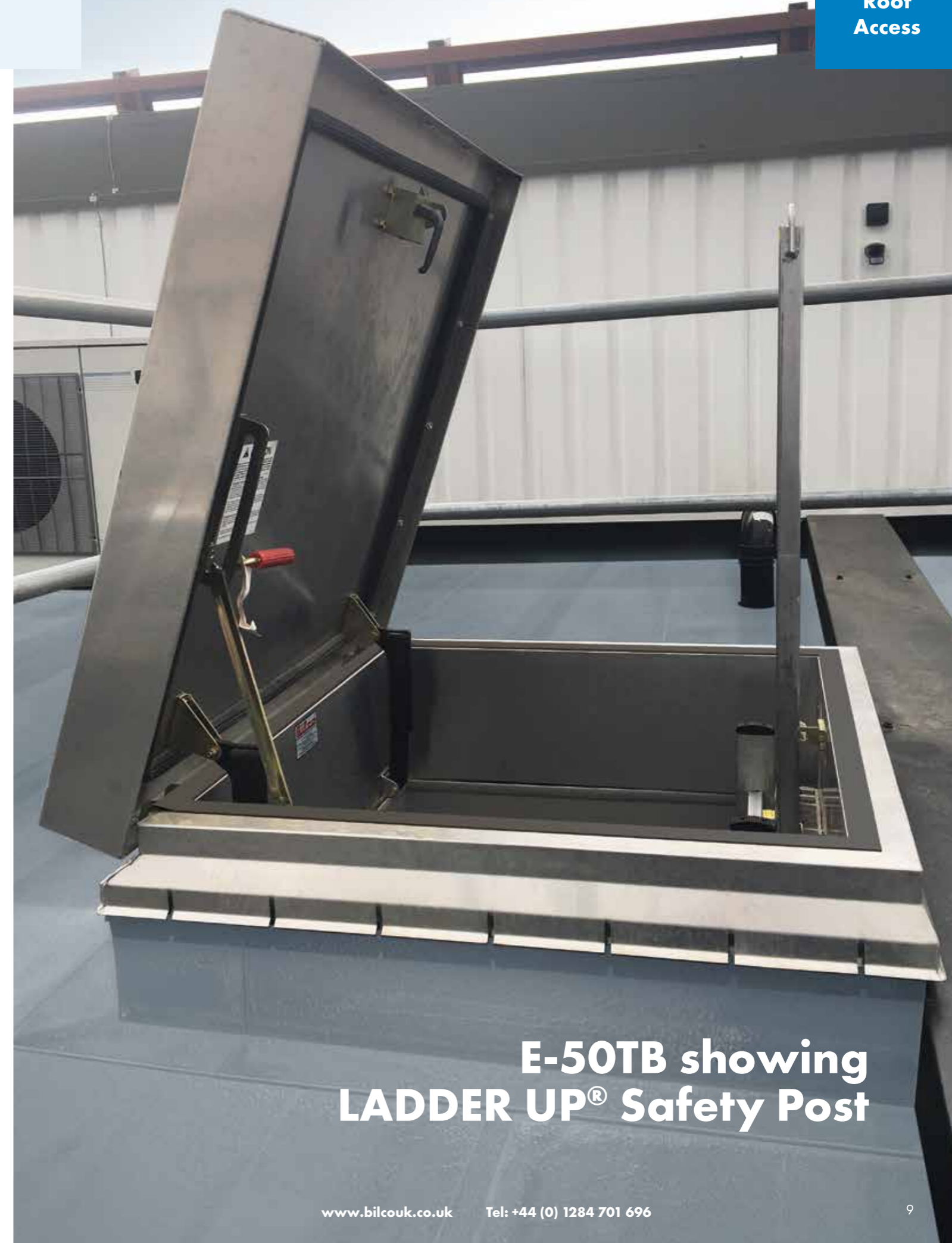

**E-50TB showing
LADDER UP® Safety Post**

Companionway Access

Solid Insulated Aluminium Cover

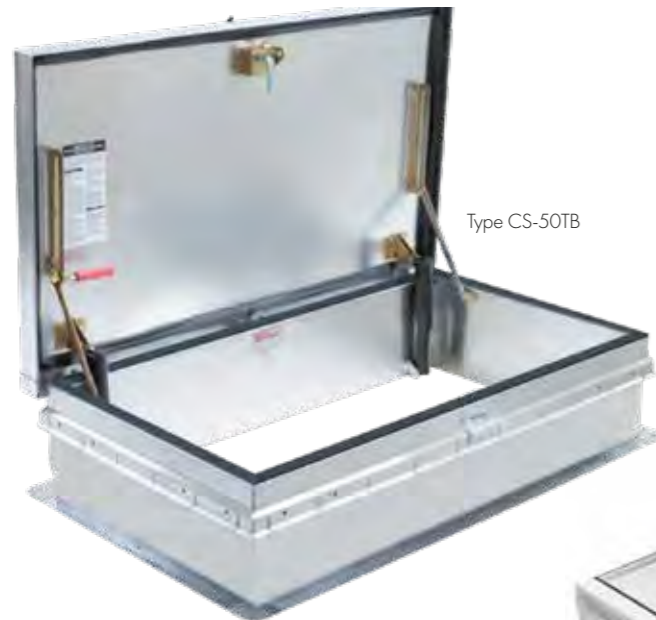

Type CS-50TB



BILCO UK RECOMMENDS access via a companionway or retractable ladder with a type CS-50TB roof access hatch

Powered Clear Skylight

Provides convenient access to roof areas with the added benefit of natural daylight. The innovative sliding cover design features an electric actuator that opens the double-layer thermoformed polycarbonate dome cover.



Type SKY Flatglass Access

NOTE

Handrails maintain a balanced position on the ladder.

Head height clearance of 1200mm minimum is required

Maximum single climb 3m (BS4211- 7.2).

For climb height of above 3m a rest platform is required.

COMPANIONWAY ACCESS SPECIFICATIONS

SOLID INSULATED ALUMINIUM COVER

PERFORMANCE CHARACTERISTICS:	Thermally broken. 75mm thick polyisocyanurate.
CURB:	305mm high. 140mm flange with 11mm holes provided for securing to the roof deck.
LIFTING MECHANISM:	Compression springs as standard.
HARDWARE:	Heavy stainless steel pintle hinges. Spring latch with interior and exterior turn handles. Interior and exterior padlock hasps. Automatically locks in the open position with a rigid hold open arm.
FINISH:	Mill finish aluminium.
OPTIONS:	Powered Operation. Polyester Powder Coating. Curb Liners. Locking options.

POWERED CLEAR SKYLIGHT

	Opens to 180°. 60mm thick extruded polyurethane.
	250mm high. 150mm flange with 9mm holes provided for securing to the roof deck.
	Single rotating actuator mounted on sliding carriage.
	Double layer polycarbonate dome (tested for impact resistance to EN1873 Class SB1200). Glazed interior (double-layer security glass - classified 2(B)2 according to EN 12600:2004).
	White PVC profile and powder coated metal.

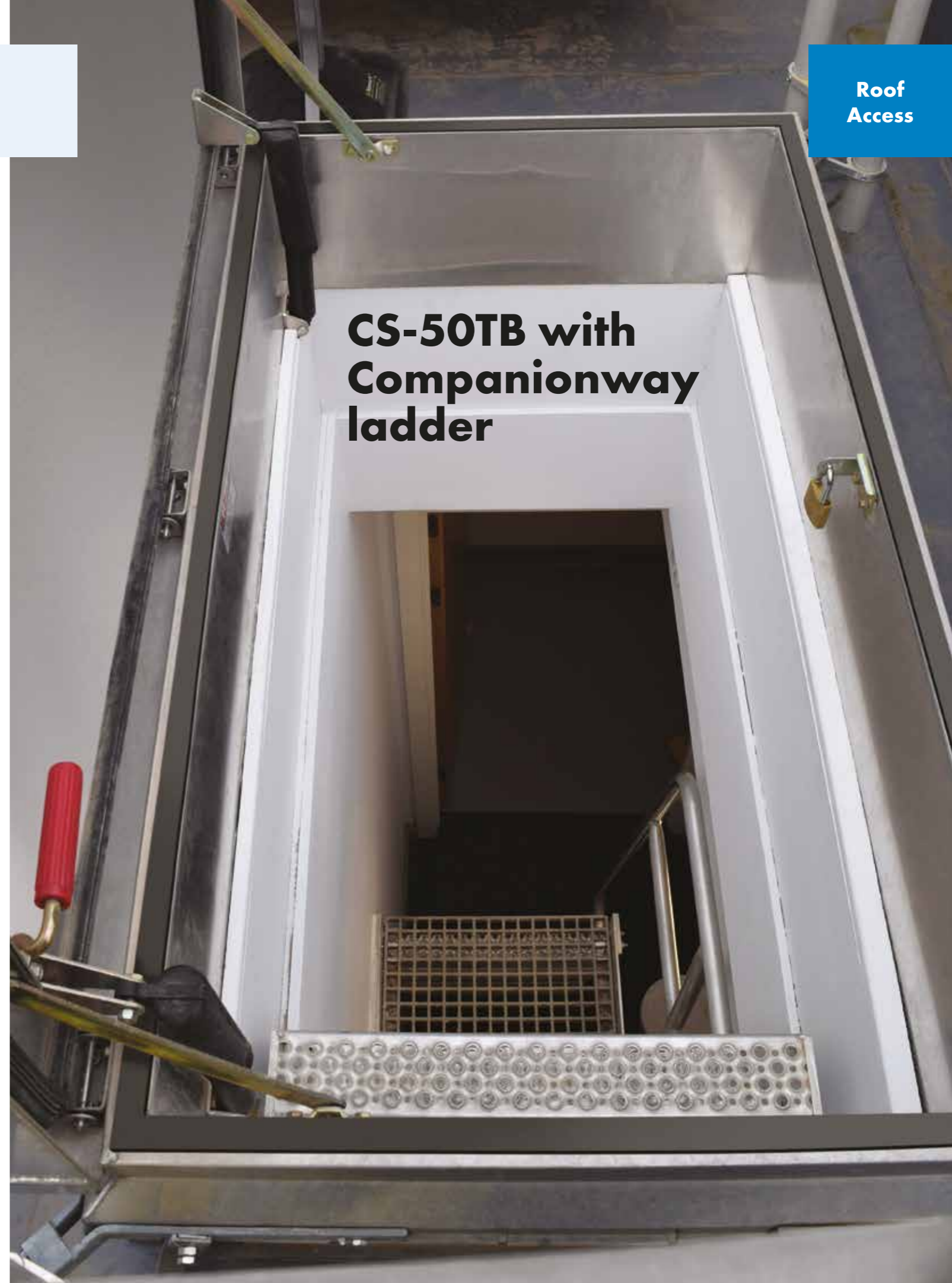

CS-50TB with Companionway ladder

Fixed Staircase (Service Stair)

Solid Insulated Aluminium Cover



Type L-50TB

NOTE

Size of the Roof Hatch should be sufficient to maintain a head clearance of 2000mm as detailed in Building Regulations Part K.



BILCO UK RECOMMENDS access via a fixed staircase with type L-50TB and SSY-50TB roof access hatches

SSY-50TB - used with a fixed stairway showing motorised option

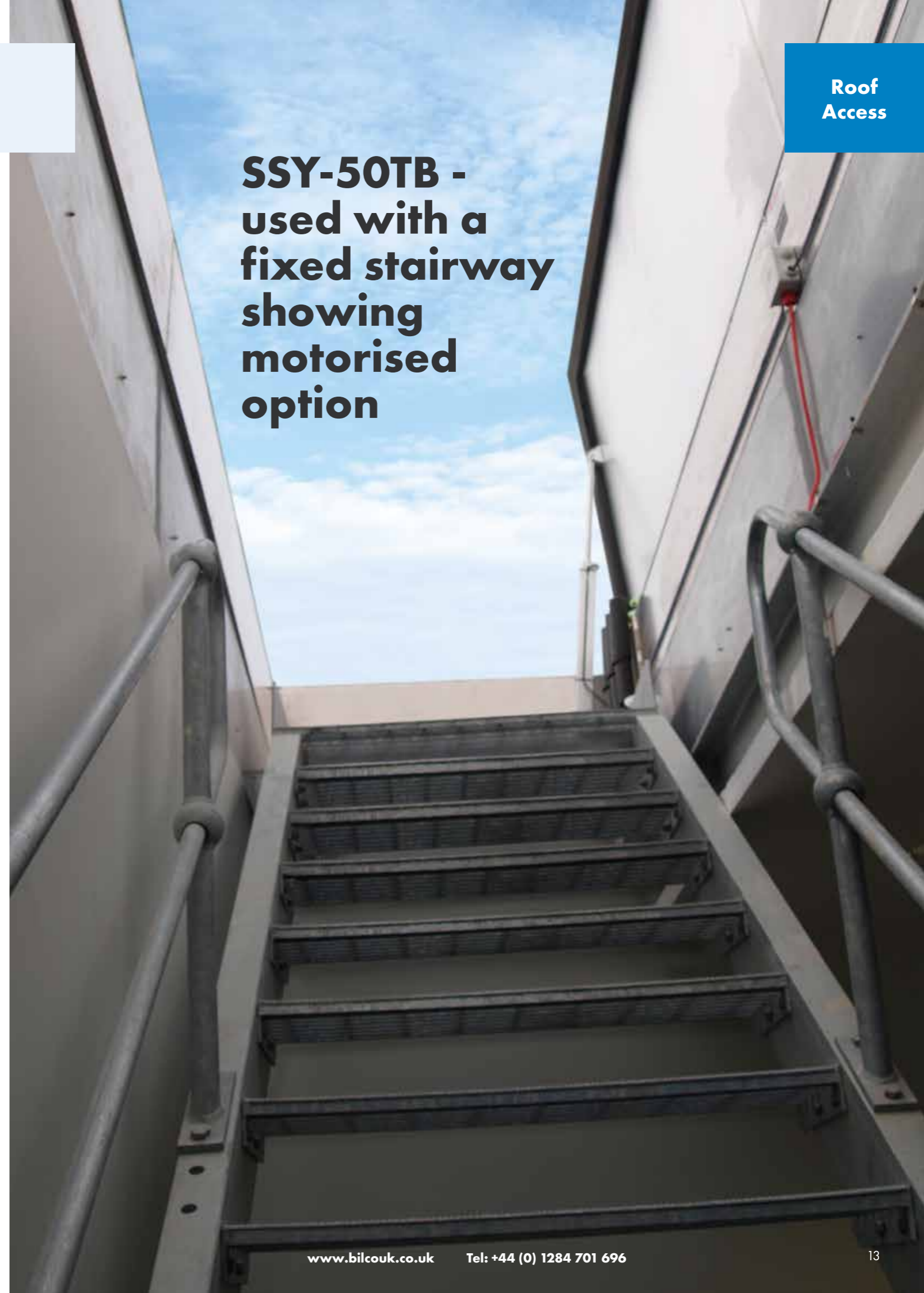

FIXED STAIRCASE (SERVICE STAIR) SPECIFICATIONS

PERFORMANCE CHARACTERISTICS:	Thermally broken. 75mm thick polyisocyanurate.
CURB:	305mm high. 140mm flange with 11mm holes provided for securing to the roof deck.
LIFTING MECHANISM:	Compression springs as standard.
HARDWARE:	Heavy stainless steel pintle hinges. Spring latch with interior and exterior turn handles. Interior and exterior padlock hasps. Automatically locks in the open position with a rigid hold open arm.
FINISH:	Mill finish aluminium.
OPTIONS:	Powered Operation. Polyester Powder Coating. Curb Liners. Locking options.

Equipment Access

Single Leaf (Standard hatch)

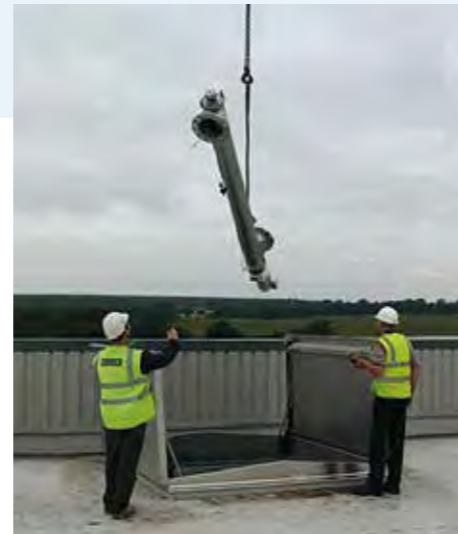

NOTE
If used with a fixed vertical ladder so personnel access is possible, we recommend that it is fitted with a motorised option. Call office for details.

SPECIAL SIZES
Special sizes are available to specific customer order across all Bilco UK doors to order to allow for a much larger options of access openings.

Double Leaf (Special order)



EQUIPMENT ACCESS SPECIFICATIONS

SINGLE LEAF

PERFORMANCE CHARACTERISTICS:	Thermally broken. 75mm thick polyisocyanurate.
CURB:	305mm high. 140mm flange with 11 mm holes provided for securing to the roof deck.
LIFTING MECHANISM:	Compression springs as standard.
HARDWARE:	Heavy stainless steel pintle hinges. Spring latch with interior and exterior turn handles. Interior and exterior padlock hasps. Automatically locks in the open position with a rigid hold open arm.
FINISH:	Mill finish aluminium.
OPTIONS:	Powered Operation. Polyester Powder Coating. Curb Liners. Locking options.

DOUBLE LEAF

	50mm thick polyisocyanurate
	305mm high. 114mm flange with 11 mm holes provided for securing to the roof deck.
	Compression springs as standard.
	Heavy stainless steel pintle hinges. Two point latch Interior and exterior padlock hasps. Automatically locks in the open position with a rigid hold open arm.
	Mill finish aluminium.
	Powered Operation. Polyester Powder Coating. Curb Liners. Locking options.

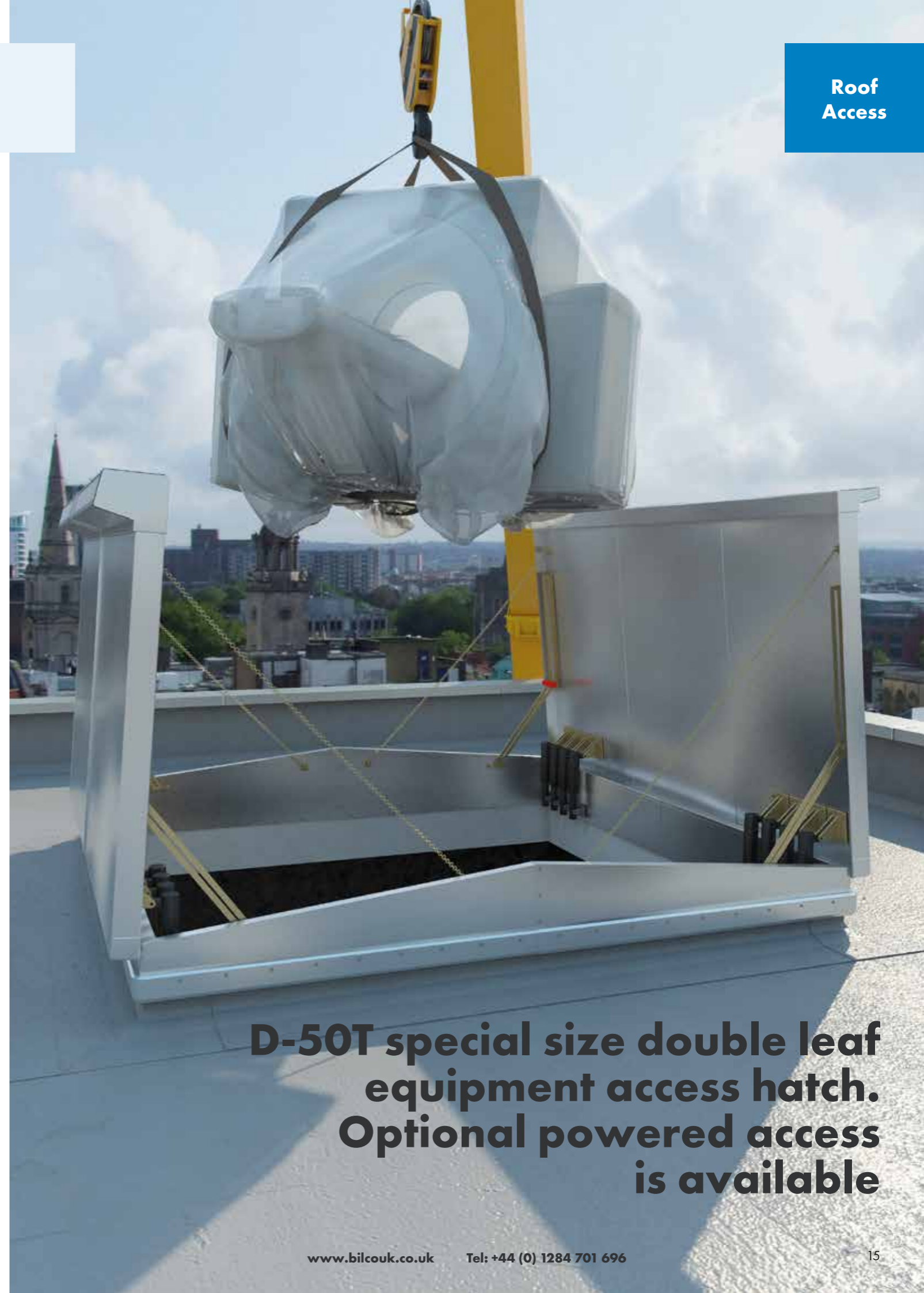

D-50T special size double leaf equipment access hatch. Optional powered access is available

Smoke Vents

Smoke Vents

Bilco UK smoke ventilators are fully compliant to the Construction Products Directive 89/106/EEC and EU Regulation No 305/2011. The evaluation is based upon the requirements of EN12101-2 2003-09.

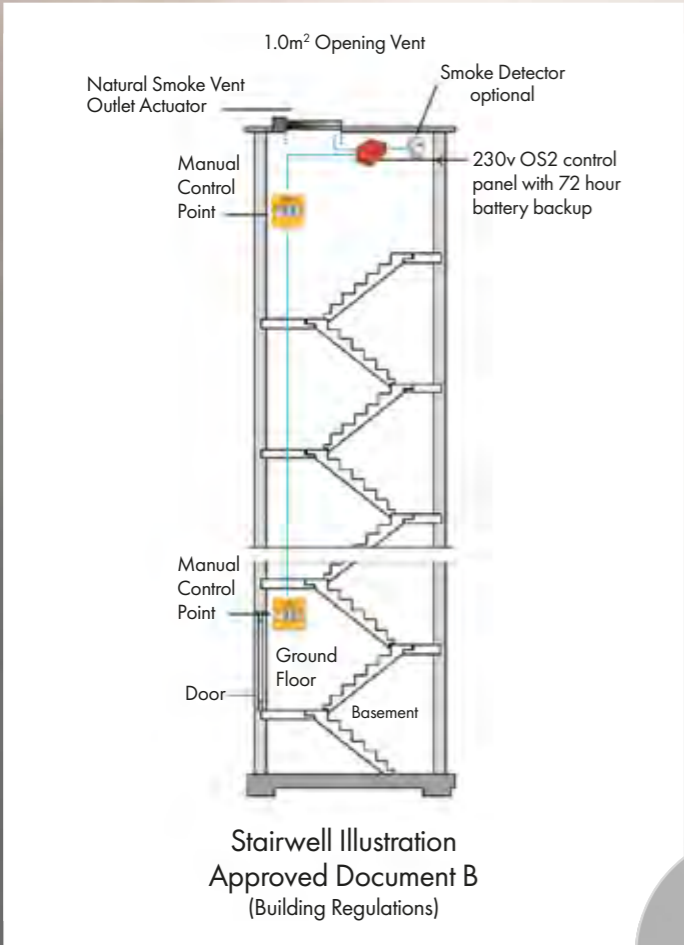

Linear actuator opens the cover to the fire open position of 140 degrees within 60 seconds

Curb mounted junction box



Closed cell EPDM sponge gasket



Enclosed hinge assembly

Fully insulated cover and curb. 50mm thick faced rigid polyisocyanurate thermal insulation board

Standard product - aerodynamic clear vent areas of 1m² and 1.5m²

Wind deflector



Insulated curb with capflashing readily accepts roofing felts, reducing installation time and costs



Flange with pre-drilled fixing points for easy installation



Natural Smoke and Heat Exhaust Ventilators (NSHEV)

Single Leaf with Solid Insulated Aluminium Cover (140° opening)



Type ESW-50REM

Double Leaf with Solid Insulated Aluminium Cover (90° opening)



Type UDF-50REM - shown without wind deflector

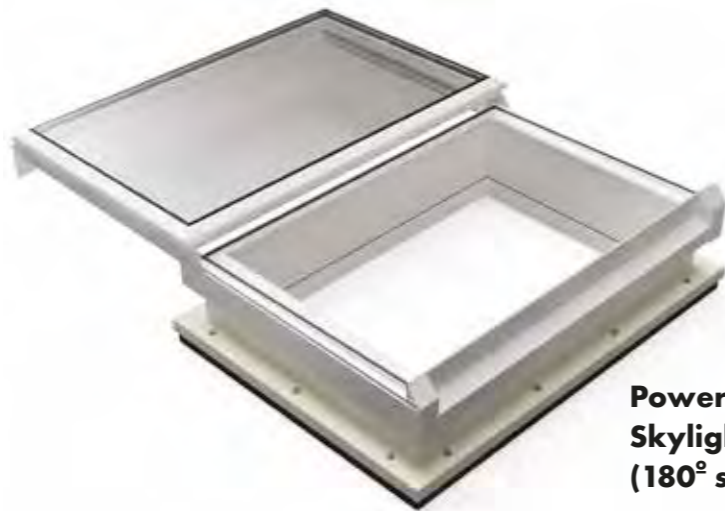

Type SKY-1MF

Powered Clear Skylight / Vent NSHEV (180° slide opening)



BILCO UK RECOMMENDS access via a fixed vertical ladder with all smoke vents. Retractable ladders are NOT recommended

NSHEV SPECIFICATIONS

SOLID INSULATED ALUMINIUM COVER

PERFORMANCE CHARACTERISTICS:	50mm thick polyisocyanurate.
CURB:	305mm high. 114mm flange with 11mm holes provided for securing to the roof deck.
LIFTING MECHANISM:	ESW: Single linear actuator. UDF: Two linear actuators per cover (4 in total)
HARDWARE:	Heavy stainless steel pintle hinges.
FINISH:	Mill finish aluminium.
OPTIONS:	Polyester Powder Coating. Curb Liners.

POWERED CLEAR SKYLIGHT

	Opens to 180°. 60mm thick extruded polyurethane.
	250mm high. 150mm flange with 9mm holes provided for securing to the roof deck.
	Single rotating actuator mounted on sliding carriage.
	Double layer polycarbonate dome (tested for impact resistance to EN1873 Class SB1200). Glazed interior (double-layer security glass - classified 2(B)2 according to EN 12600:2004).
	White PVC profile and powder coated metal.

ESW-50REM with fixed vertical ladder and LADDER UP® safety post

Also available...

Acoustic Smoke Vents

Ideal for concert halls, theatres, casinos, sporting arenas and other applications. Contact Bilco UK office for details.



Control Panel

THE HEART OF THE SYSTEM

MCP
Designed to allow the Fire Officer to manually override the smoke control system through a user friendly interface. Design includes an open button and a close/reset button, which are accessed by lifting the clear front door. Dumb Reset Key required to close in accordance with PrEN 12101-9.
1RPREM-02

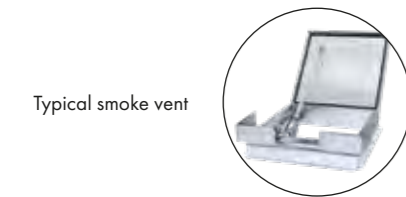
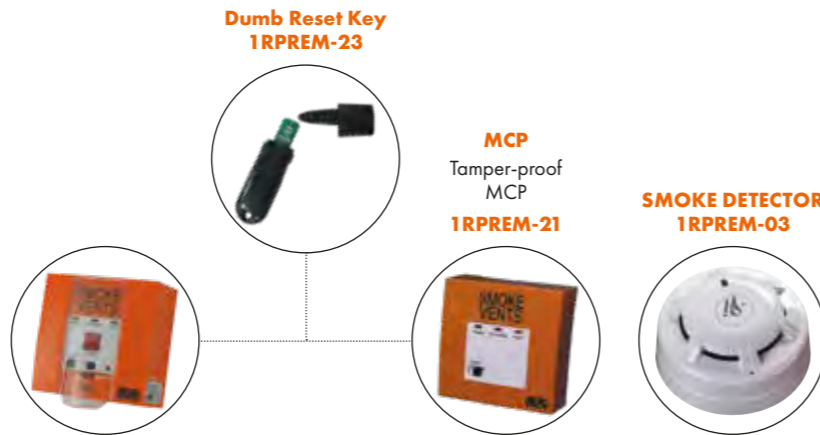

CONTROL PANEL
The OS2 control unit can be a stand-alone management system or it can be integrated into a fully networked fire alarm or BMS system. OS2 accepts a supply of 230V AC 50/60 Hz from a 3A fused un-switched spur and has a current rating of 2A. Output is 24V DC 2-Channels. Combined output must not exceed 8A. Intermittent - 6 mins in any 1 hour; 5A continuous. Other options are available. The 72 hour backup battery module comprises 2 x 12VDC 7.0AH sealed lead-acid batteries.
1RPREM-09



CONTROL PANEL KIT
Comprises: control panel, fireman's switch (MCP) and smoke detector
1RPREM-01

OPEN/CLOSE SMOKE VENT SWITCH
Stainless steel face plate, designed to be used as a keyed or paddle switch
1RPREM-08 (keyed)
1RPREM-08A (paddle)



OPEN/CLOSE SWITCH
10 amp durable white plastic retractable switch
1RPREM-10

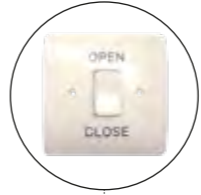

WEATHERPROOF OPEN/CLOSE SWITCH
Made from steel the keyed switch is sprung to centre and cannot be operated without the security key
1RPREM-11 (keyed)
1RPREM-11A (paddle)



PANIC BUTTON
For use above or below smoke vent for emergency escape
1RPREM-11B



AUTO/MANUAL CONTROL SWITCH
To be used in conjunction with thermostat and/or rain sensor. Stainless steel face plate, designed to be used as a 2 position switch
1RPREM-07

THERMOSTAT
Industry standard 10° to 30°C range
1RPREM-04

WIND SPEED SENSOR
1RPREM-26

RAIN SENSOR
Robust and cost effective
1RPREM-15

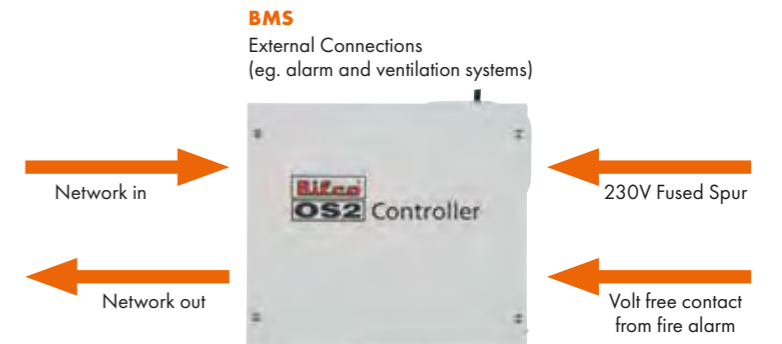

Fixed Vertical Ladder

Type BL without safety cage

FIXED VERTICAL LADDER SPECIFICATIONS

ALUMINIUM

LADDER: Alloy Class 1 Stiles: 73 x 25mm.
Class 1 heavy duty rung.
Stand off brackets from 50 x 10mm alloy bar.
Fixings in stainless steel.

LADDER WIDTH: 488mm.

FINISH: All alloy mill finish.

OPTIONS: LADDER UP® Safety Post.

TYPE	SIZE	APPROX. WEIGHTS
BL-A-1	2.0 - 2.8m	12-14kg
BL-A-2	Above 2.8 - 3.6m	14-18kg
BL-A-3	Above 3.6 - 4.4m	18-22kg
BL-A-4	Above 4.4 - 5.2m	22-26kg
BL-A-5	Above 5.2 - 6.0m	26-30kg
BL-A-SS	Special sizes available on request	

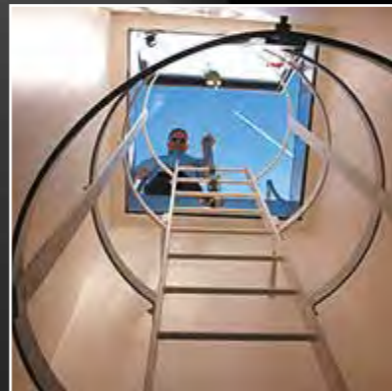

Manufactured in aluminium, our range of fixed vertical ladders are ideal for personnel access. These can be provided with a safety cage or guardrail if required to meet the relevant British Standards.

All of our fixed vertical ladders are manufactured to comply with BS4211:2005 + A1:2008 and offer a much safer alternative to using movable ladders.

We also offer a range of companionway ladders and retractable ladders if required. Please contact our office for more details.

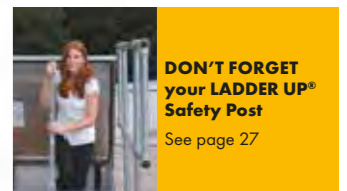

DON'T FORGET
your LADDER UP®
Safety Post
See page 27

Ladder Security Gates

BZP steel hinged gate with or without blocking plate.
Magnetic locking option available.

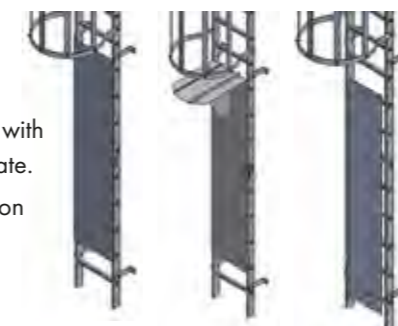

Retractable Section

ONLY available on aluminium ladders.

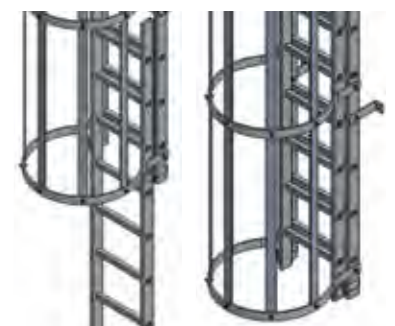

Fixed Vertical Ladder

Type BL-WH with safety cage

TYPE BL-WH SPECIFICATIONS

ALUMINIUM

LADDER: Alloy Class 1 Stiles: 73 x 25mm box section.
Class 1 heavy duty rung.
Stand off brackets from 50 x 10mm alloy bar.
Fixings in stainless steel.

LADDER WIDTH: 488mm.

SAFETY CAGE: Cages above 2200-3000mm.

STRAP: 50 x 10mm alloy bar.
5 x straps as BS4211: 2005 + A1 2008.

FIXINGS: Dome head bolts.

FINISH: All alloy mill finish.

OPTIONS: LADDER UP® Safety Post.

TYPE	SIZE	APPROX WEIGHTS
BL-A-WH1	2.0 - 2.8m	15-18kg
BL-A-WH2	Above 2.8 - 3.6m	18-20kg
BL-A-WH3	Above 3.6 - 4.4m	20-26kg
BL-A-WH4	Above 4.4 - 5.2m	26-32kg
BL-A-WH5	Above 5.2 - 6.0m	32-37kg
BL-A-WHSS	Special sizes available on request	

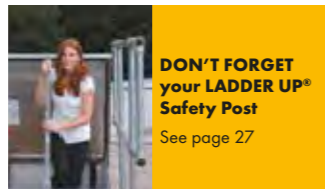

DON'T FORGET
your LADDER UP®
Safety Post
See page 27



Fixed Vertical Ladder

Type BL-WG with safety cage and guardrail

TYPE BL-WG SPECIFICATIONS

ALUMINIUM

LADDER: Alloy Class 1 Stiles: 73 x 25mm box section.
Class 1 heavy duty rung.
Stand off brackets from 50 x 10mm alloy bar.
Fixings in stainless steel.
Guardrail Height: 1100mm.

LADDER WIDTH: 488mm.

SAFETY CAGE: Cages above 2200-3000mm.

STRAP: 50 x 10mm alloy bar.
5 x straps as BS4211: 2005 + A1 2008.

FIXINGS: Dome head bolts.

FINISH: All alloy mill finish.

OPTIONS: LADDER UP® Safety Post.

TYPE	SIZE	APPROX WEIGHTS
BL-A-WG1	2.0 - 2.8m	36-38kg
BL-A-WG2	Above 2.8 - 3.6m	38-40kg
BL-A-WG3	Above 3.6 - 4.4m	40-46kg
BL-A-WG4	Above 4.4 - 5.2m	46-51kg
BL-A-WG5	Above 5.2 - 6.0m	51-57kg
BL-A-WG-SS	Special sizes available on request	



According to BS 4211:2005 + A1:2008,
a self-closing gate should be fitted where
a ladder breaks existing handrail.

Companionway Ladder

Type BL-COMP. Complying with the recommendations of BS 5395: Part 3

COMPANIONWAY SPECIFICATIONS

ALUMINIUM

- Stiles: Aluminium
- Folded aluminium treads
- Brackets from 50 x 10mm alloy bar
- Fixings in stainless steel
- All alloy in mill finish
- Grabrail height: 300mm (nom)
- Overall ladder width: 590mm
- Ladder angle: 75 degree (nom)

TYPE	SIZE	APPROX WEIGHTS
BL-COMPA1	Up to 1.5m	Up to 32kg
BL-COMPA2	Above 1.5 - 2.0m	32-37kg
BL-COMPA3	Above 2.0 - 2.5m	37-41kg
BL-COMPA4	Above 2.5 - 3.0m	41-46kg
BL-COMPAS	Special sizes available on request	

Note:

For climb height of above 3m a rest platform is required.
An additional bracket must be specified if a LADDER UP® Safety Post is being used. Please call Bilco UK office for details.



Ladder Access Safety Options

Ideal for safer access and a safer working environment

LADDER UP® Safety Post

Telescopic, spring balanced post permanently mounts to the top two rungs of any fixed ladder.

Gives a positive hand-hold enable safe, upright and balanced entry or exit.

Automatically locks in the fully raised position to provide a firm and steady hand-hold

Handy release lever allows the post to be easily lowered to its retracted position.

Available in four different finishes and corrosion resistance.
If using in a corrosive atmosphere, specify LU-2, 3 or 4.

TYPE		APPROX WEIGHTS
LU1-BLK	Steel black enamel	11 kg
LU2	Hot-dip galvanised steel	11 kg
LU3	Type 304 stainless steel	11 kg
LU4	Aluminium	7kg



Adjustable mounting



Automatically locks off



Telescopic design



Handy release lever

Bil-Guard® Hatch Rail System

Easy-to-install rail fall protecting system.



Pivoting mounting sleeve



Self-closing gate latch



Self-closing stainless steel hinges

Retractable Ladders

Retractable ladders are designed for use in areas where the floor space must be kept clear such as schools, hospitals etc.

All Bilco UK retractable ladders are manufactured to EN 14975 from die-cast aluminium alloy with two heavy duty counter-balanced springs incorporated into pivot brackets.

Supplied with a single telescopic handrail and protective non-slip feet, they are designed to achieve load bearing of 200kg per tread.

Recommended for use with CS-50TB and Sky Access.



BL-Z

The BL-Z incorporates a 580mm wide x 18mm white block wood backboard which should be attached to a structural support, not the internal face of the hatch.

Product Code: BL-Z

Size Code	Floor to Ceiling Height (mm)	No. of Treads	Tread Size* (mm)	Normal Tread Rise (mm)	Min. Hatch Length (mm)	Weight (kg)
1	Up to 2500	9	350 x 140	277-280	1000	30
2	2501-2790	10	350 x 140	277-280	1000	31
3	2791-3090	11	350 x 140	277-280	1100	32
4	3091-3390	12	300 x 140	277-280	1270	33

* Alternative sizes on request.

Note: When ordering use the product code and add size code after e.g. BL-Z-1. Image shows BL-Z with additional step.

The following options can be ordered for all types of Bilco UK retractable ladders (at the time of ordering):

Both BL-Z and BL-ZBOX

Additional telescopic handrail.
Grabrail.
Additional step (if required).

BL-Z only

Operation from above with eyebolt.

BL-ZBOX only

Lining depth up to 1470mm deep.
Operation from above cable/ring pull operation.
Electrically operated trapdoor and stair (contact Bilco UK office for details).



BL-ZBB Backboard

For additional, adjustable steps and safety holds, with two grab rails, between the ladder and the top of the structural opening (or roof hatch if fitted).

Product Code: BL-ZBB

Size Code	No. of Treads	Height* (mm)	Width (mm)	Weight** (kg)
1	2	1000	590-1100	20
2	3	1001-1250	590-1100	23

* Ladder fitted at bottom of backboard.

** Maximum weight assuming 1100mm wide.

Note: When ordered with a BL-Z the backboard will be delivered fitted to the ladder. When ordering use the product code and add size code after e.g. BL-ZBB-1.

BL-ZBOX

The BL-Z BOX offers all the benefits and options of the BL-Z plus it comes with either an 18mm thick laminated, insulated, wood trapdoor and lining or a steel hatch to provide improved fire-ratings.

The standard lining is 500mm deep from the underside of hatch to the bottom of the closed trapdoor.

The fire-rated trapdoor is made from 2 layers of 1.5mm thick sheet steel infilled with mineral wool to give 3 fire rating options (please specify):

Fire Rating Option	Mineral Wool Thickness (mm)	Fire Resistance (mins)
F30	38	30
F60	60	60
F90	75	90

Available Tread Sizes

200/250/300/350/380mm wide x 140mm deep.

430/480/580mm wide x 160mm deep.

Product Code: BL-ZBOX

Size Code	Floor to Ceiling Height (mm)	No. of Treads	Normal Tread Rise (mm)	Min. Hatch Length (mm)	Weight Wood (kg)	Weight Steel (Fire Rated) (kg)
1	Up to 2500	9	277-280	750	85	160
2	2501-2790	10	277-280	800	86	161
3	2791-3090	11	277-280	900	87	162
4	3091-3390	12	277-280	1000	88	163
5	3391-3690	13	277-280	1300	95	178
SS	Special Size	Contact Bilco UK office for details				

Note: When ordering use the product code and add size code after e.g. BL-ZBOX-1.

BL-ZBOXBB Backboard

The Backboard is mounted separate to the BL-ZBOX and requires the BL-ZBOX liner to be a height of 240mm, so should only be ordered at the time of ordering the ladder.

Product Code: BL-ZBOXBB

Size Code	No. of Treads	Height* (mm)	Width (mm)	Weight** (kg)
1	2-3	1000	590-1100	20
2	3-4	1001-1250	590-1100	23

* Ladder fitted at bottom of backboard.

** Maximum weight assuming 1100mm wide.

Note: Always order at the same time you order the ladder.

When ordering use the product code and add size code after e.g. BL-ZBOXBB-1.



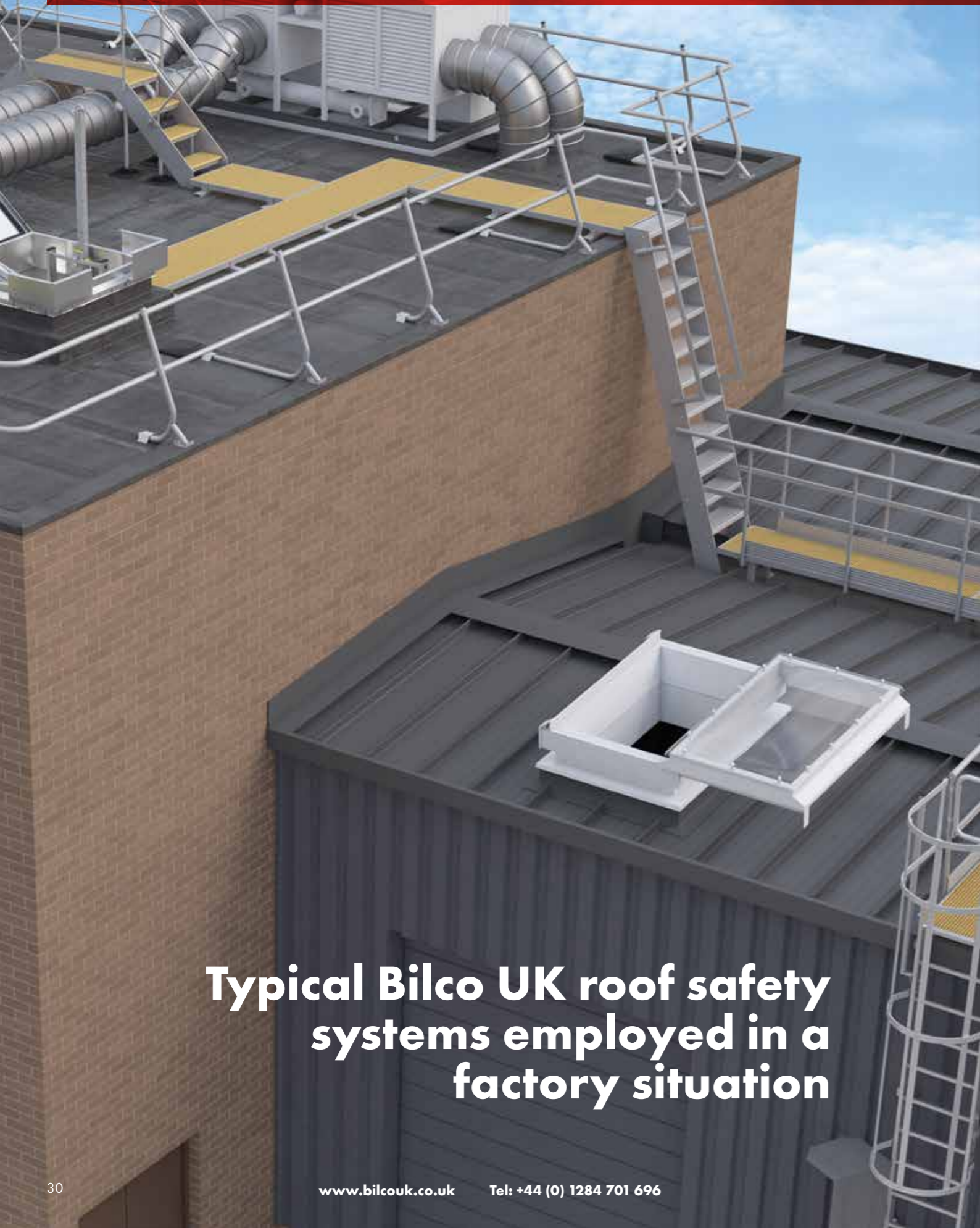

Typical Bilco UK roof safety systems employed in a factory situation

Bilco UK offers a range of roof safety systems, all of which can be customised to suit specific customer needs. For full details see our website or call the office.

Step-over Units

Wherever transit is required over ducting, parapet walls, conduit or any roof obstruction a step over unit, freestanding or fixed to the ground, is the safest access available.

Complying with the Work at Height Regulations and, where applicable, BS5395: Part 3 step over units give flexible access over a range of widths and heights while keeping the operative safe and enclosed in handrail at all times.

Fixing points for permanent fixing to surface

BP45-A-F Aluminium.

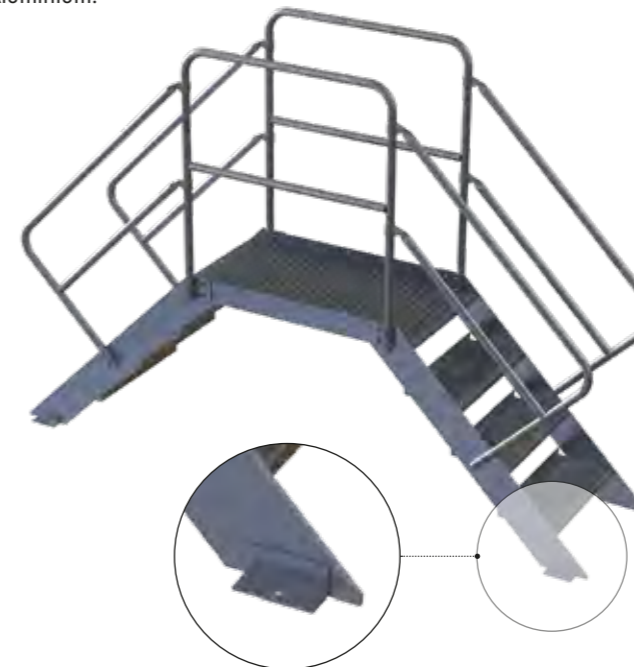

Free-standing with adjustable feet

BP45-A-FS Aluminium.

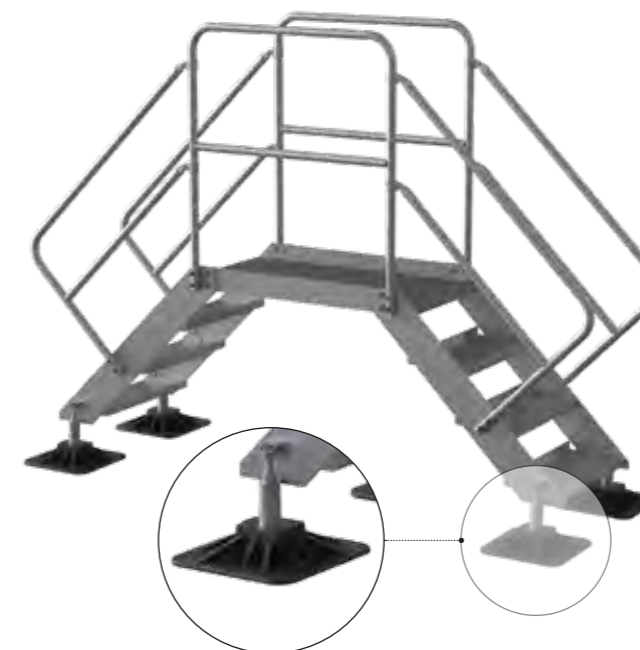

Roof Safety

BWALK-A Roof mounted walkways

The Bilco UK walkway range is designed and manufactured following the recommendations of BS5395: Part 3. Manufactured in Aluminium with non-slip GRP walkway panels.

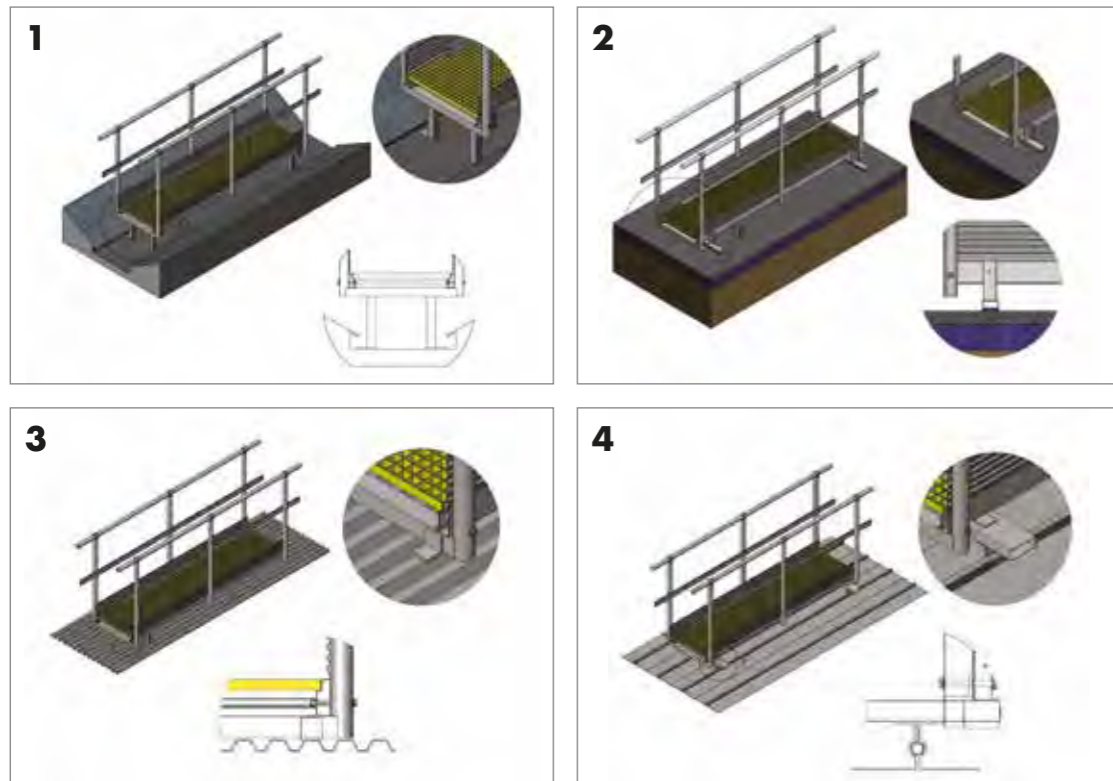

- 1. Pedestal**
For gutter cleaning access.
- 2. Free-standing**
When a roof cannot be penetrated.
- 3. Penetrative fixing**
When a roof is a suitable structure.
- 4. Raised Seam**
Uses a clamp bracket to secure.

Roof Edge Protection

Work at Height Regulations 2005 require handrails be fitted to prevent falls. Bilco UK provides a totally flexible, maintenance-free, galvanised steel handrail system which avoids the need to mechanically fix the system to the roof itself. It can run in straight runs or continuous, flexible route runs.

ROOFEP-1 Handrail including free-standing posts.

ROOFEP-2 Free-standing end including rubber counterweight.



JOIN OUR LIVE CPD WEBINARS

**AVAILABLE ONLINE
OR FACE TO FACE**

Presented by our Specification
Sales Managers

View our full schedule of CPD
dates at bilcok.co.uk

REGISTER TODAY

CPD from Bilco UK

Bilco UK have launched the "Safe Access all Areas" CPD which examines the full range of access products from roof access hatches to floor doors and also looks at the use of smoke vents, ladders and safety products.

It looks at the most appropriate solutions for access requirements and examines what considerations should be made when specifying these for a project.

The CPD, whilst not being overly technical, is intended to give the audience a good understanding of what needs to be thought about when looking for the most appropriate, cost effective, and safest solution when specifying access products. It is ideal for Architects, Facility Managers, Project Managers, - in fact, for anyone who is involved in the specification, selection or procurement of access products.

Bilco UK also offer a tailored CPD to your specific requirements should you wish more detailed information on Smoke Vents, covering the latest legislation on CE marking, or on Roof access hatches. In addition, we offer an Access 360 CPD. This looks at safe, practical and aesthetic solutions for clean, maintenance-free access to roof, ceiling, wall and floor services.



To book your place on one of our CPD seminars call **01284 701 696**, email cpd@access-360.co.uk or register at bilcok.co.uk/cpd-seminars



Bilco UK Ltd

Pavilion 7, Fornham Business Court, Hall Farm
Fornham St. Martin, Bury St. Edmunds, Suffolk, IP31 1SL

Tel: +44 (0) 1284 701 696

Email: bilcouk@bilco.com

www.bilcouk.co.uk



Bilco UK, Profab Access and Howe Green form
the Access 360 division of Tyman UK & Ireland.

LADDER UP® is a registered trade mark of the Bilco company.

We reserve the right to make design changes or to withdraw designs and products
shown throughout this brochure without notice as we deem advisable.

BUK-Brochure-01 -Apr22



ISO 9001 – 0006730
ISO 14001 – 0006729

